



Capacity from 500 kg to 10000 kg







- 17-4 PH STAINLESS STEEL
- COMBINED ERROR $\leq \pm 0.02\%$ (0.017% C4)
- IP68 PROTECTION RATING





CAPACITY	kg	ACCURACY CLASS			NET WEIGHT (kg)
		C3	C4		
500		•	•	•	2.1
1000		•	•	•	2.1
2000		•	•	•	2.1
5000		•	–	•	4.2
7500		•	–	•	4.2
10000		•	–	•	4.2

ON REQUEST

CERTIFICATIONS

-  OIML R60 C3
-  Complies with the Eurasian Customs Union standards
-  Equivalent of the CE marking for the United Kingdom
-  Complies with United Kingdom regulations for legal for trade use

CERTIFICATIONS ON REQUEST

-  Linearity test
-  ATEX II 1GD (zone 0-1-2-20-21-22) (CE - UK CA)
-  IECEx (zone 0-1-2-20-21-22)
-  OIML R60 C4
-  Complies with the Eurasian Customs Union standards for use in potentially explosive atmospheres

DIMENSIONS (mm)

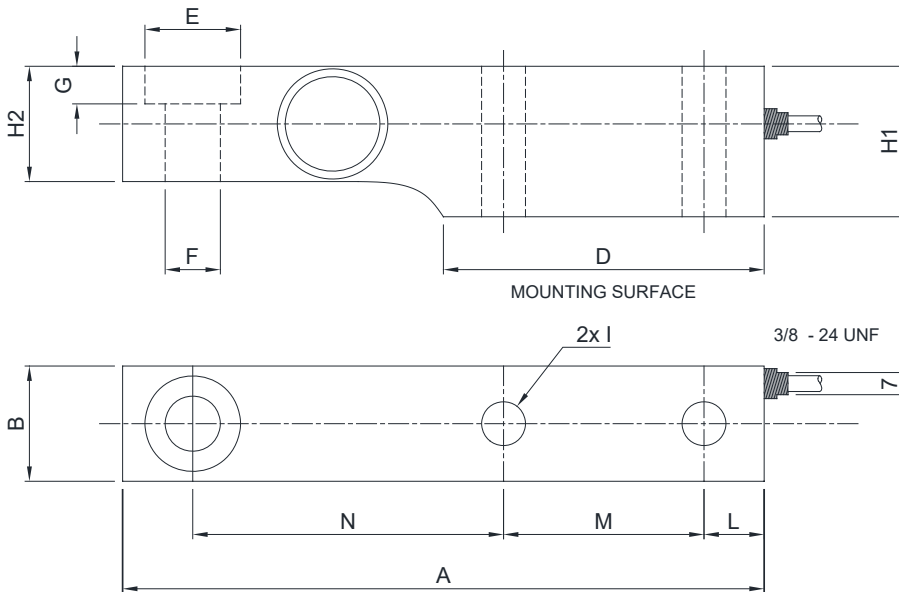

	500 kg 1000 kg 2000 kg	5000 kg 7500 kg	10000 kg
A	203.2	235	235
B	36.48	47.5	55
D	101.6	111.2	111.2
E	Ø30.3	Ø41.3	Ø41.3
F	Ø17.5	Ø25.5	Ø25.5
G	11.9	15.75	15.75
H1	47.63	69.9	69.9
H2	36.5	47.6	58.6
I	Ø14	Ø22	Ø25
L	19.05	20.6	20.6
M	63.5	66.7	66.7
N	98.45	123.8	123.8

For the load cell fixing screws, provide the tightening torque indicated in the table

Screw	M12		M20		M24	
	6.8	8.8	6.8	8.8	6.8	8.8
Tightening torque	50 Nm	795 Nm	290 Nm	400 Nm	500 Nm	690 Nm

TECHNICAL FEATURES

Material	17-4 PH stainless steel	
OIML R60 Accuracy class • Verification intervals	C3 • 3000	C4 • 4000
Nominal load (E max)	500 - 1000 - 2000 5000 - 7500 - 10000 kg	500 - 1000 - 2000 kg
Minimum verification interval (V min)	E max / 10000	E max / 15000
Combined error	≤ ±0.02%	≤ ±0.017%
Protection rating	IP68	

Rated output	2 mV/V ± 0.2% *	Input resistance	350 Ω ± 3.5
Temperature effect on zero	0.0018% °C	Output resistance	350 Ω ± 3.5
Temperature effect on span	0.0014% °C	Zero balance	< ±1%
Compensated temperature range	-10 °C / +40 °C	Insulation resistance	≥ 5000 MΩ
Operating temperature range	-35 °C / +65 °C	Safe overload (% of full scale)	150%
Creep at nominal load in 30 minutes	0.02%	Ultimate overload (% of full scale)	300%
Max supply voltage without damage	18 V	Deflection at nominal load	0.4 mm

* Calibrated current output

ELECTRICAL CONNECTIONS

Cable length	5 m (500-7500 kg); 10 m (10000 kg)
Cable diameter	5 mm
Cores	4 x 0.20 mm ²

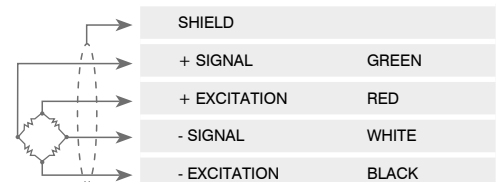

The Company reserves the right to make changes to the technical data, drawings and images without notice.